

AQUAFORMS

NCOL 2 - Surface Mount



PROJECT

DATE

COMMENTS

STANDARD FEATURES

- Nautical Cast Oval Luminaire
- Die-Cast Aluminum Housing with Opal Glass Lens
- Different Trims Available
- Also Available for Medium Base E26 Lamp
- Additional CCT Options Available Upon Request



SERIES	MODEL	TRIM	LAMP	LUMENS	CCT	VOLT	CONTROL	COLOR	OPTIONS
NCOL-2	6100	NG = No Guard	12W LED	1985	K4 = 4000K	120/277 UNV	DD = 0-10V	TAL = Textured Aluminum	EM = Emergency Backup PE = Photocell
		CG = Cast Guard	16W LED	2592	K4 = 4000K			TBK = Textured Black	
		TH = Top Hood						TBZ = Textured Bronze	
		CB = Cross Band						TWH = Textured White	
		TRB = Triple Band						CC = Custom Color	
		DCB = Dual Cross Band						RAL = RAL Color	

ORDERING INFORMATION

SERIES	MODEL	TRIM	LAMP	LUMENS	CCT	VOLT	CONTROL	COLOR	OPTIONS

ORDERING EXAMPLE: NCOL-2 - 6100 - CG - 12W LED - 1985 - K4 - 120/277 - DD - TAL

Consult factory for voltage and other lamp options. Product specifications subject to change without notice.

1. Programmable drivers at the PACE factory
2. Color tunable
3. Capable of remote dimming
4. Can be equipped with motion sensors for on/off functioning
5. Can be equipped with light sensors for dusk-to-dawn automatic on/off operation
6. Bluetooth commissioning sensor capability for Android and iOS



PACE Illumination 5500 West 111th Street | Oak Lawn, Illinois 60453 | 708-499-1700 | quotes@paceillumination.com

Although PACE has prepared the information contained in this document with all due care, PACE does not warrant or represent that the information is free from errors or omission. Whilst the information is considered to be true and correct at the date of publication, changes in circumstances after the time of publication may impact on the accuracy of the information. The information may change without notice and PACE is not in any way liable for the accuracy of any information printed and stored or in any way interpreted or used.

In the interest of product improvement, Pace reserves the right to make technical and product specification changes without notice. Consult factory for voltage and other lamp options.

REV DATE:
09192023

AQUAFORMS

NCOL 2 - Surface Mount



SIZES

- 12.6" x 8"

MOUNTING

- Surface wall or ceiling mount

COLOR

- Textured or smooth polyester powder coat finishes
- RAL colors available

DIMENSIONS

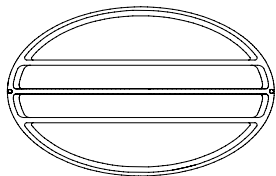
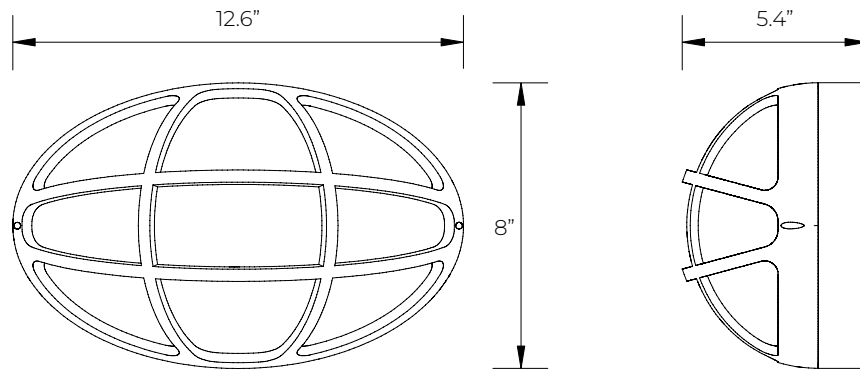

TRB
Triple Band

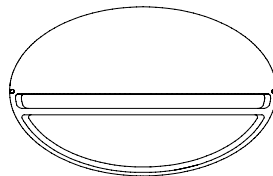

TH
Top Hood

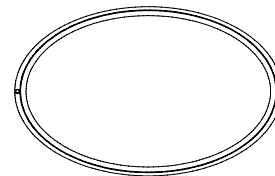

NG
No Guard

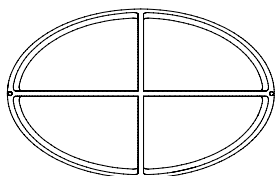

CB
Cross Band

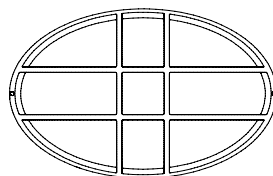

DCB
Dual Cross Band

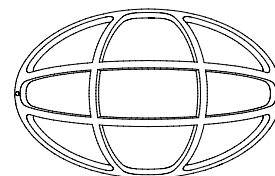

CG
Cast Guard

