



URBANICA

UAPT 1 - post top

SIZES

Small = 18" diameter
Large = 24" diameter

MOUNTING

Post top or wall arm bracket

COLOR

Textured or smooth polyester powder coat finishes
RAL colors available

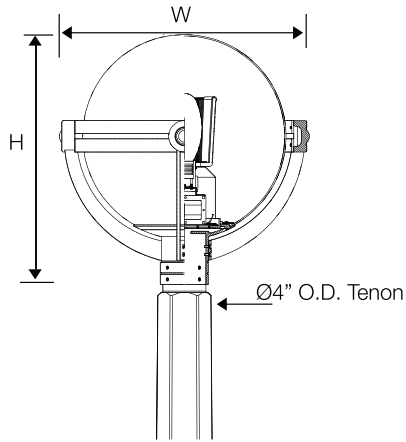

Wall mount bracket detail

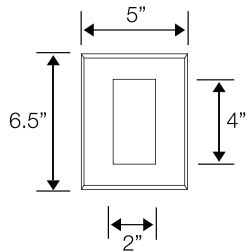

WMB-1 = wall mount bracket

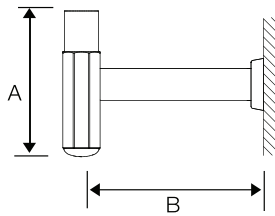

WMB-2 = wall mount bracket

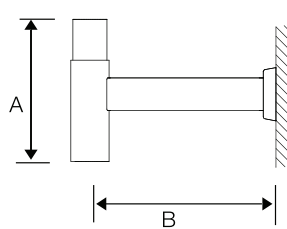

SL = Stacked Louver



HPL = High performance louver



Glass refractor Type III or V



Band Styles

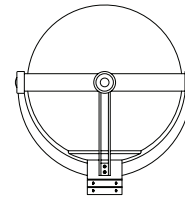

WB = WIDE BAND

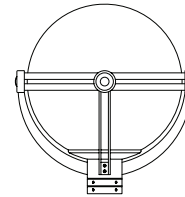

DB = DOUBLE BAND

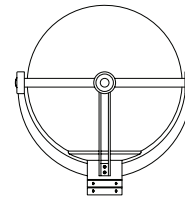

SB = SINGLE BAND

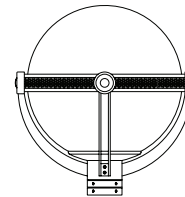

PB = PERF BAND

Mounting Configurations

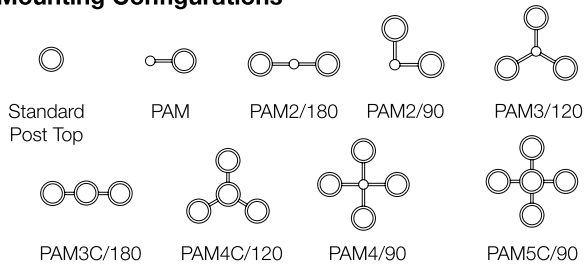

	W	H	A	B	EPA
Small	18.0"	19.0"	11.0"	18.0"	1.3
Large	24.0"	24.0"	13.0"	22.5"	1.95

Although PACE has prepared the information contained in this document with all due care, PACE does not warrant or represent that the information is free from errors or omission. Whilst the information is considered to be true and correct at the date of publication, changes in circumstances after the time of publication may impact on the accuracy of the information. The information may change without notice and PACE is not in any way liable for the accuracy of any information printed and stored or in any way interpreted or used.

In the interest of product improvement, Pace reserves the right to make technical and product specification changes without notice. Consult factory for voltage and other lamp options.